



Alain Marguerit

Route barriers

469

Disponibile nei seguenti materiali e dimensioni:
Available in the following materials and sizes:
Disponible dans les dimensions et matériaux suivants:
Disponibile en los siguientes materiales y tamaños:
Disponível nos seguintes materiais e tamanhos:
Erhältlich in den folgenden Materialien und Größen:



Acciaio Zincato e Verniciato / Galvanized and Powder Coated Steel
Acier Galvanisé et Thermolaqué / Acero Galvanizado y Barnizado
Aço Galvanizado e Pintado / Stahl, Verzinkt und Pulverbeschichtet



Acciaio Corten / Corten Steel
Acier Corten / Acero Corten
Aço Corten / Corten-Stahl

1460 mm
130 (80) mm
H 1000 mm

Disegni / Drawings / Plans / Dibujos / Desenhos / Zeichnungen/ p.: 710

Fissaggio / Fixings / Fixation / Fijación / Fixação / Befestigung:
Predisposizione per tasselli - Cementazione
Pre-drilled for anchors - Below ground installation
Réservation chevilles - Scellement
Predisposición para tacos - Cimentación
Preparação para buchas - Cimentação
Mit Bohrungen für Verschraubung - Zementierung

ZAFFIRO

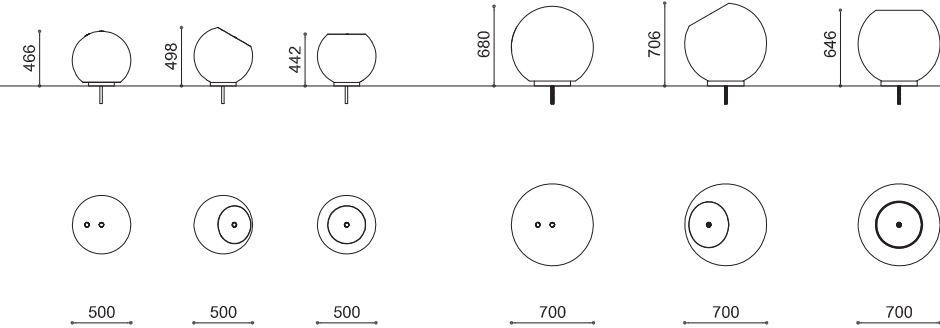

CORALLO



OPALE

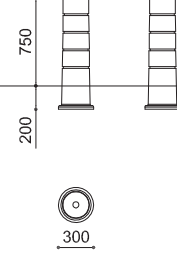

HARLEM

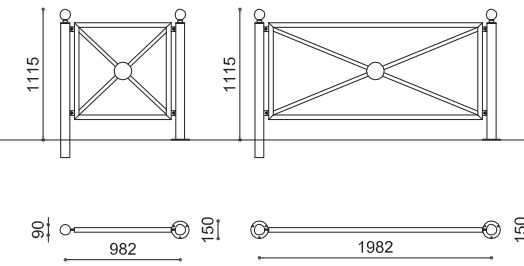

MASCHERA

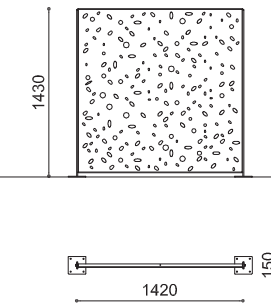

CROSS

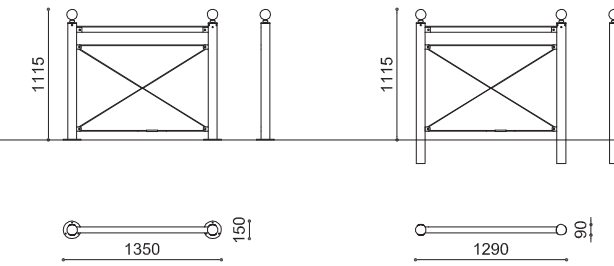

CUBE

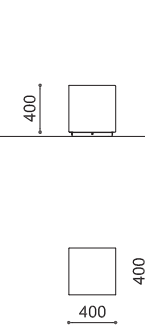

HESPERIA

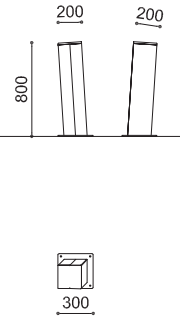

VISION

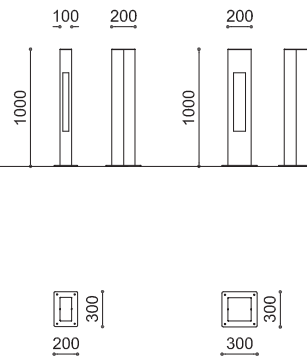

GENESIS

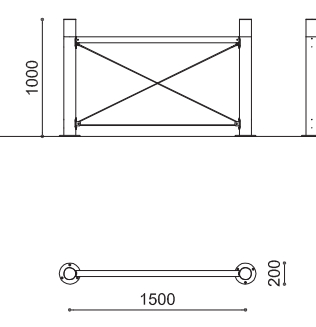
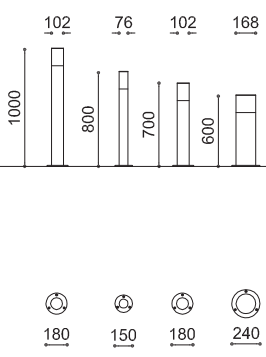

NEA

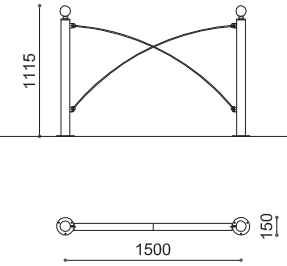

VOILA'

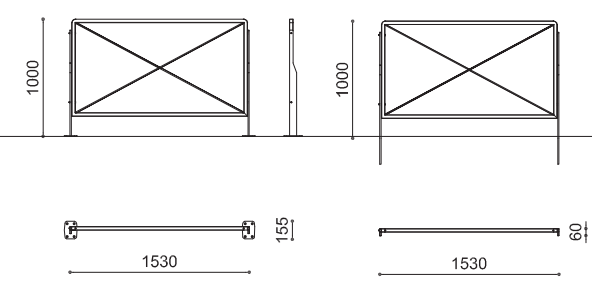

VOILA' WOOD

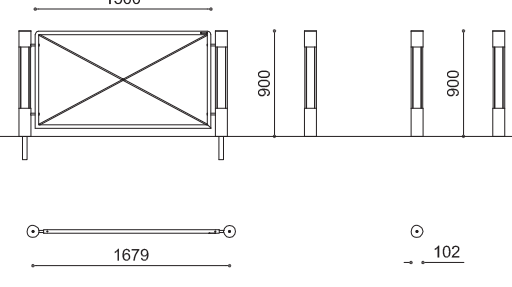

DIX WOOD

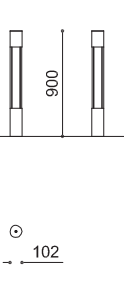

ROUTE

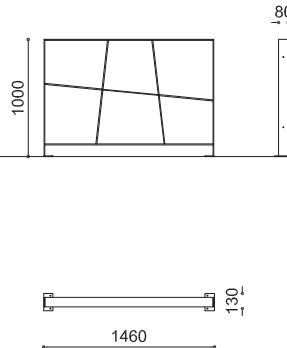

VERSO P

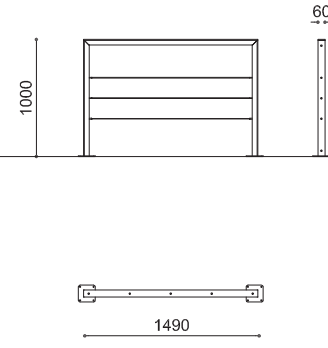

VERSO X

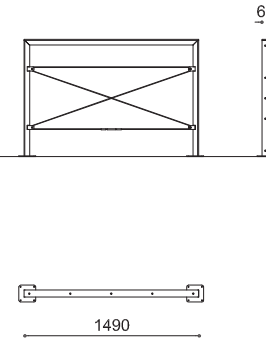

VERSO 240-490

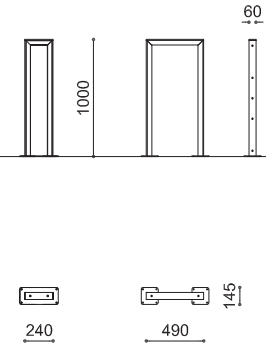

ICS

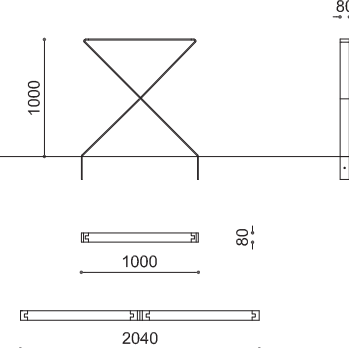

PALUS

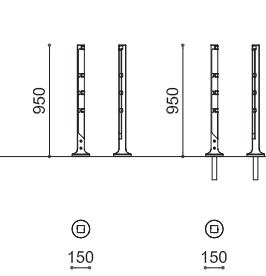

TRANSEO

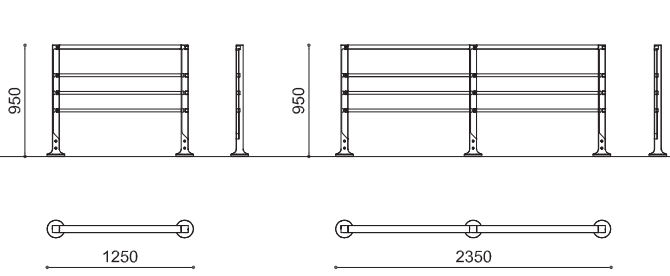

710

711