

Ocean Hpc

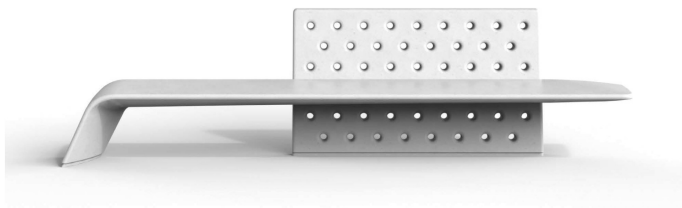

Cantilevered bench made of HPC (High Performance Concrete) velluto - natural smooth, equipped with a monolithic backrest decorated with holes which occupies half of the seat.

Variant code: 0074041

Size and weight: Width 3090mm
Length 610mm
Height 820mm
Weight 885kg

Materials: HPC (High Performance Concrete) velluto - natural smooth

Finishes: HPC (High Performance Concrete) velluto - natural smooth

Color:
HPC colour to be chosen between grey, white and dark grey.

Finishes:

Fixing: Below ground installation

Technical drawing:

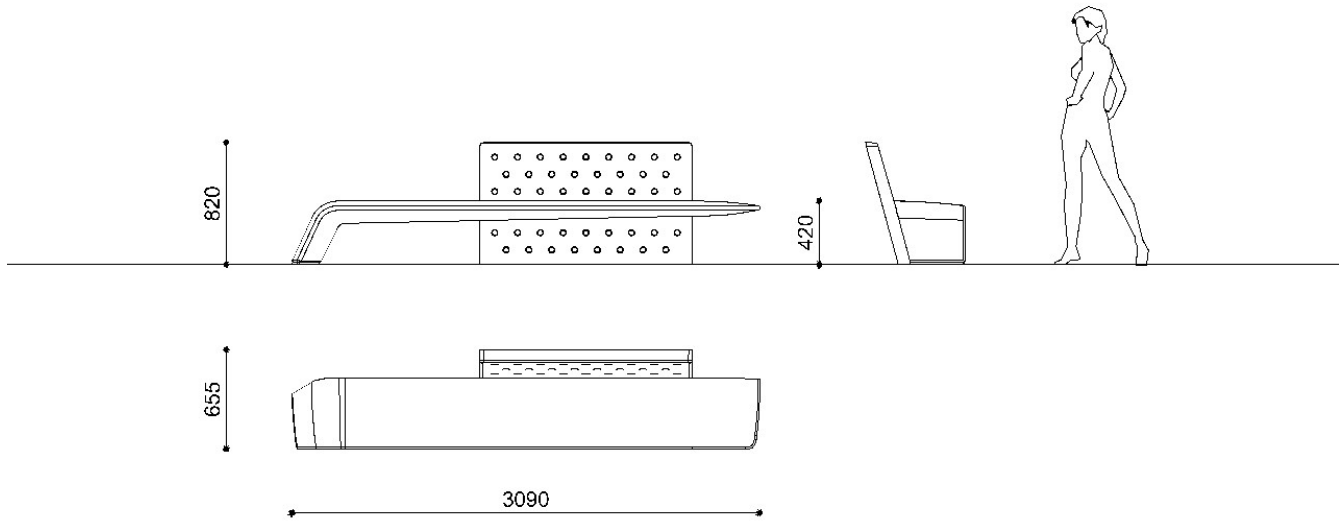

metalco.it
info@metalco.it



HPC (HIGH PERFORMANCE CONCRETE)

Our HPC is available in five different colors (white, grey, dark grey, green and yellow) and it is provided, as standard, with VELLUTO – natural smooth finish.

Characterized by textured appearance, HPC can present not uniform cloudy effects of color and light cracks, which are physiological aspects of this material.

Upon request, when technically feasible, it is possible to perform polishing operations.

The finished products are treated with a protective varnish, and upon request, anti-graffiti treatment can be also applied.

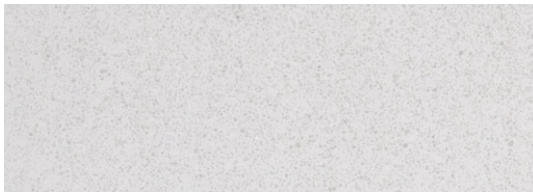

WHITE POLISHED



WHITE VELLUTO - NATURAL SMOOTH



GREY POLISHED



GREY VELLUTO - NATURAL SMOOTH



DARK GREY POLISHED

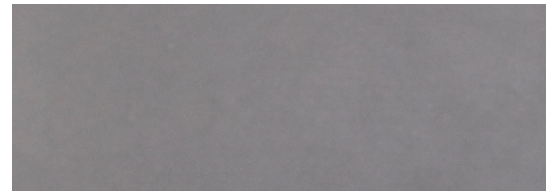

DARK GREY VELLUTO - NATURAL SMOOTH

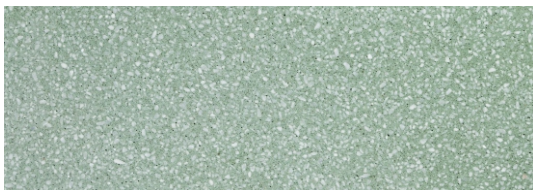

GREEN POLISHED

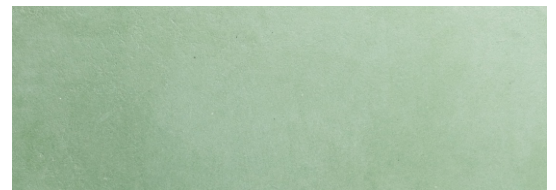

GREEN - NATURAL SMOOTH

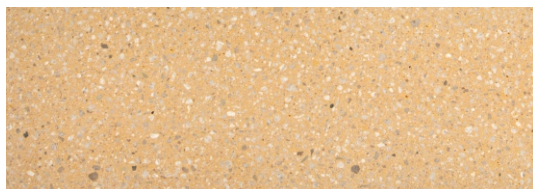

YELLOW POLISHED

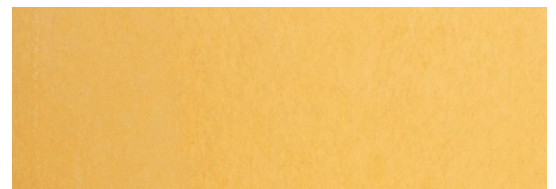

YELLOW VELLUTO - NATURAL SMOOTH

N.B.: Please note that the images reproduced on these pages are purely indicative. For more information about the materials, visit our website

metalco.it
info@metalco.it

